

AVXMTGHR1D

7" LCD MONITOR

WITH BUILT-IN DVD PLAYER

FOR REAR SEAT ENTERTAINMENT

Audiovox **MTG**

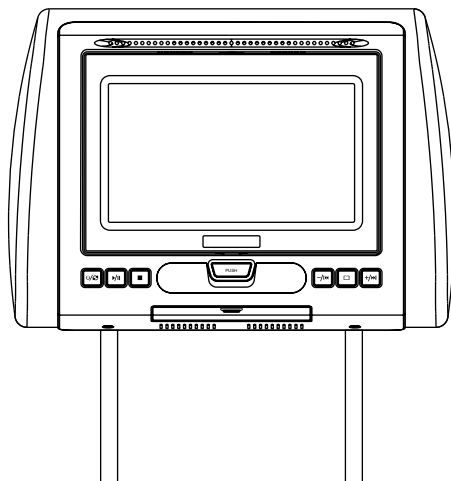

ATTENTION This product is designed for use on 2009 and prior model year vehicles. It is not lawful to install on 2010 model year vehicles or later.

MISE EN GARDE Ce produit est destiné à être utilisé sur des véhicules de modèles 2009 et antérieurs. Il est illégal de l'installer sur des modèles 2010 et plus récents.

ATENCIÓN Este producto está diseñado para utilizarse en vehículos modelo 2009 y anteriores. Es ilegal instalarlo en vehículos modelo 2010 y posteriores.

OPERATION MANUAL / INSTALLATION GUIDE



128-8944A

Important Notice

Installation of headrest products require careful planning and preparation. Be extremely careful of seats that have airbags built into them. Keep wiring away from any air bag wiring (usually identified by yellow connectors and yellow wire jackets). Damage to air bag wiring can result in personal injury to vehicle occupants. If you have any questions regarding wire routing or installation in a vehicle, please contact Audiovox Technical Support at 1-800-225-6074.

When connecting power and ground in a mobile video installation, insure that the ACC wire is fused at the point where it is connected to the vehicle ACC wiring. Failure to do so can result in damage to the vehicle if a short circuit develops between the vehicle connection point and the mobile video product.

An LCD panel and/or video monitor may be installed in a motor vehicle and visible to the driver if the LCD panel or video monitor is used for vehicle information, system control, rear or side observation or navigation. If the LCD panel or video monitor is used for television reception, video or DVD play, the LCD panel or video monitor must be installed so that these features will only function when the vehicle is in "park" or when the vehicle's parking brake is applied.

An LCD panel or video monitor used for television reception, video or DVD play that operates when the vehicle is in gear or when the parking is not applied must be installed to the rear of the driver's seat where it will not be visible, directly or indirectly, to be operator of the motor vehicle.

Licensed under one or more of the following patents:

Patent NOS. 7,245,274 , 6,899,365 and 6,678,892

FEATURES

- 7" Digital Thin Film Transistor (TFT) Active Matrix Liquid Crystal Display (LCD) Monitor
- Built-in DVD Player
- Last position memory for DVD player
- Three Audio / Video Source inputs (DVD, AV and AUX)
- USB 2.0 port / SD Card Reader input
- Screen mode selection (4:3, 16:9)
- On Screen Display (OSD) for control of picture quality and functions
- Full function remote control
- Plays DVD, CD and MP3 discs
- IR headphone (optional)

| <u>SPECIFICATIONS</u> | |
|------------------------------|---|
| Type | TFT Active Matrix LCD |
| Resolution | 480x234 |
| Pixels | 336,960 |
| Operation Temperature | 32 ~113° F (0 ~ 45° C) |
| Storage Temperature | -4 ~ 149° F (-20 ~ 65° C) |
| Backlit life | 20,000 Hours |
| Video Display System | NTSC / PAL / AUTO |
| Headphone Audio Output | 0.03W @ 32 ohms |
| Video Output | 1.0Vp-p @ 75 ohms |
| Power Source | 10V~16V DC |
| Dimension (L x W x H) | 147mm x 275mm x 200mm 5.7in x 10.8in x 7.8in |

Specifications subject to change without notice.

MATERIAL TO USE IN THIS PACKAGE:

1) AVXMTGHR1D System Monitor with DVD Player (AVXMTGHR1D) (1pc)

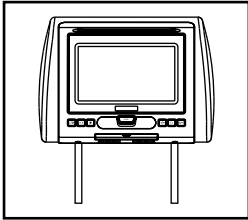

NOTE: The AVXMTGHR1D monitor has been designed to be interchangeable from one headrest to the other. The headrests will still have the Green and Red Din cables on them and should be connected to their respective connectors. The headrest cover from the manufacturer is covered with shale colored vinyl.

NOTE: Headrest cables are included with the headrest DVD player and the headrest monitor.

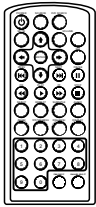

1) Remote Control
(P/N 136-5150) - (1pc)

2) AV Adapter Cable
(P/N 112B3227)-(1pc)



3) AV IN / Power Cable, 8 Pin Din to 3 RCA (Red)
(P/N 112-4149)-(1pc)

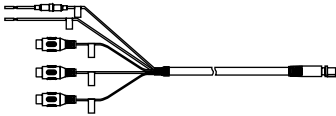

4) AV OUT Cable, 8 Pin Din to 3 RCA (Green)
(P/N 112-4160)-(1pc)



5) Black Vinyl Headrest Cover
(P/N 126-1377)-(1pc)



6) Pewter Vinyl Headrest Cover
(P/N 126-1378)-(1pc)

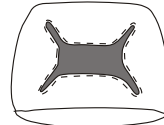

7) Shrink Tubing, Black
(P/N 138-1495)-(2pcs)



8) Support Tube Adaptor Box
(P/N 170-0161)-(1box)

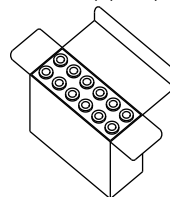

HEADREST COVER REPLACEMENT:

NOTE: If desired, replace the headrest cover before installing the headrest in the vehicle.

1. Using a Philips screwdriver, unscrew the two Philips screws and lift the bottom edge of the monitor upward.



2. Remove the velcro tabs securing the headrest cover.

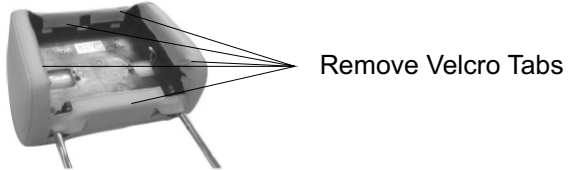

3. Replace the headrest cover with the desired color and secure the headrest cover by re-attaching the velcro tabs.



4. Place the monitor cable into the space on the right side of the headrest and lower the monitor into position to align the two Philips screws with the screw holes in the headrest. Close the screen and press the PUSH button to secure the screen.

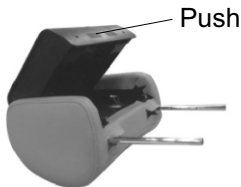

5. Tighten screws

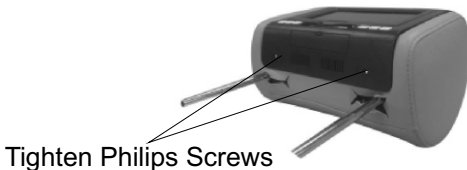

VEHICLE PREPARATION

- 1) Decide on the system configuration and the options that will be installed.
- 2) Read the manuals and get familiar with the electrical requirements and connections.
- 3) Decide on the mounting locations and methods of mounting the products that will be connected to the AVXMTGHR1D.
- 4) Prepare the vehicle by removing any interior trim necessary to gain access to the vehicle's wiring as well as all areas where interconnecting wire harnesses will be located. The mounting method, and the location will vary from vehicle to vehicle, so this manual will only focus for the installation of the AVXMTGHR1D Monitors in the supplied configuration. The best location for the AVXMTGHR1D System components is:
 - a. Monitors: Vehicle specific Headrest **NOTE:** The Master Monitor should be installed in the passenger position most used.)
- 5) Locate an accessory power source (+12VDC present when the ignition key is in the accessory and run positions. 0VDC should be present when the ignition key is in the OFF position), a constant power source (+12vdc) at all times, regardless of the ignition key and a good ground. Generally, these wires can be found at the ignition switch or fusebox.

NOTE: Ensure that both the constant and accessory power is fused at the source. Failure to do so may result in vehicle wiring damage.)
- 6) Run the wiring harnesses throughout the vehicle as necessary. (Refer to the Wiring Diagrams on page 8, as well as the wiring instructions for the individual components and accessory options being installed). Be sure, that all the wiring is protected from sharp edges and is routed in such a manner that it will not be pinched, when it is fully installed. Be sure to leave enough slack in the wiring at each component to allow sufficient working room. Be sure to leave enough slack in the monitor cables to allow the headrest to move up or down, and seat movement.
- 7) Remove all the A/V system components from their packaging and then place them in the vehicle at their respective locations.

- 8) Install the headrests:
 - a. Remove vehicle's original headrests.
 - b. insert appropriate support tube adaptors in vehicle post guides. (if needed)
 - c. Hold the headrest above the seat and insert the two cables into the vehicle support guides Make sure that the headrest is in the correct position (Display facing the rear).
 - d. Route the cables through the seat back and out the bottom of the seat while pulling the cables to remove the slack. Be sure to leave enough slack in the monitor cables to allow the headrest to move up or down.
- 9) Connect all the components together (electrically) and verify proper operation of all the system functions.

Wireless FM Modulator

The AVXMTGHR1D is equipped with a built-in wireless FM Modulator, that allows you to listen to the DVD audio signal by tuning your vehicle's radio to the selected frequency, (**CH1** 87.7MHz, (**CH2** 88.1MHz, **CH3** 88.5MHz, **CH4** 88.9MHz, **CH5** 106.7.1MHz, **CH6** 107.1MHz, **CH7** 107.5MHz, **CH8** 107.9MHz.

This feature is accessed by using the FM transmitter buttons on the remote (FMM ON/OFF, and CHANNEL SELECT).

Whenever the FM Modulator is on, broadcast reception on the vehicles radio will be poor. Switching the FM Modulator off will allow normal radio reception.

NOTE: In certain areas where there are a large number of FM radio stations (e.g. large cities, urban areas), the reception of the FM signal may not be satisfactory, resulting in static, distorted sound or signal bleed thru from strong local radio stations. This is not a defect in the product, but the result of a stronger local radio station overpowering the wireless FM transmitter in your headrest monitor.

AVXMTGHR1D WIRING DIAGRAM

Headrest Monitor

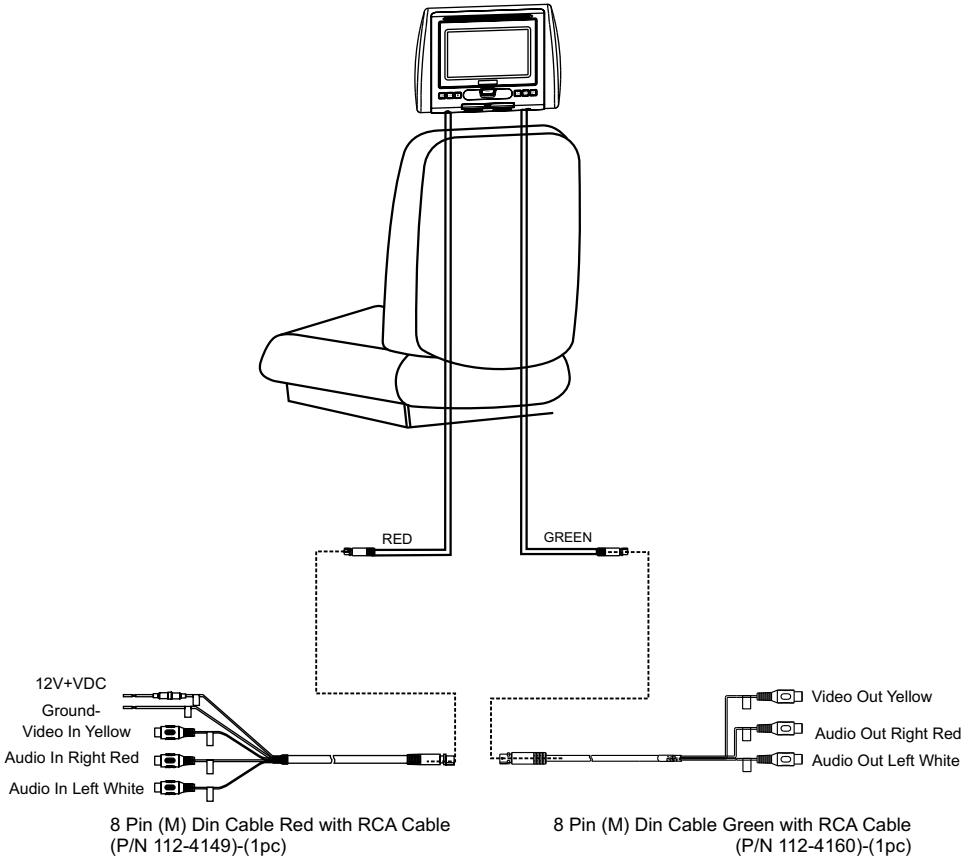

AVXMTGHR1D CONTROLS AND INDICATORS DIAGRAM (FRONT VIEW)

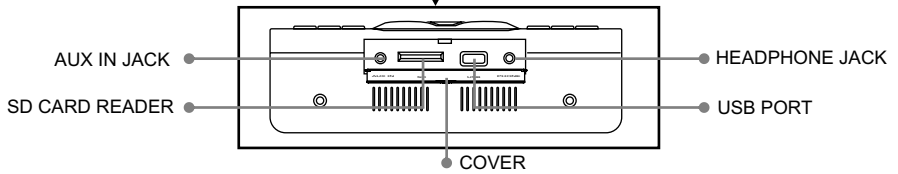
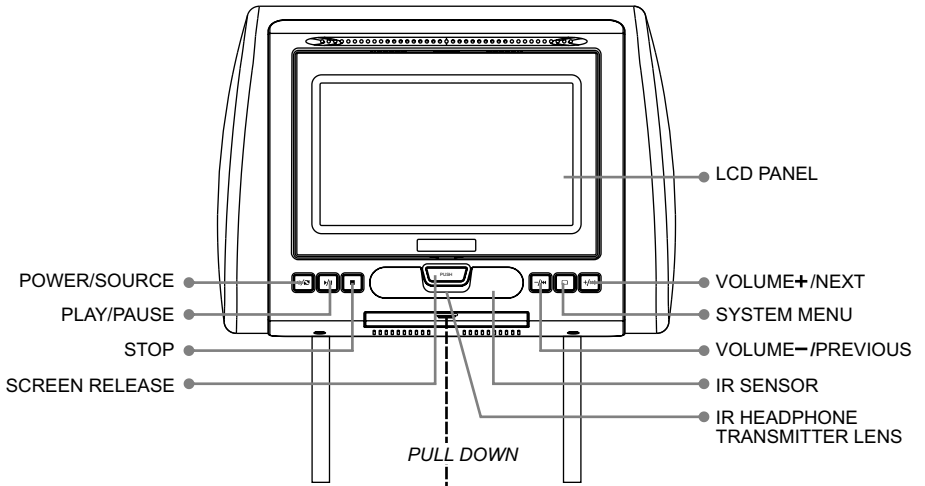

(BOTTOM VIEW)

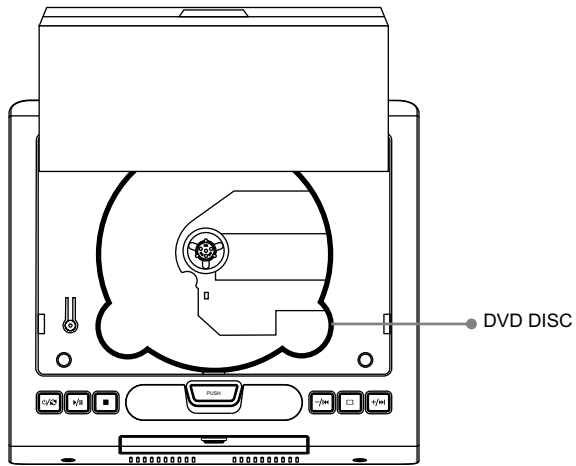

(FRONT VIEW MONITOR OPEN)

REMOTE CONTROL OPERATION

NOTE: The remote control has a battery installed with a pull tab to prevent battery discharge. Remove the pull tab before attempting to use the remote.

Battery Replacement

1. Remove the battery holder.
2. Insert the battery (CR2025) into the battery holder and insert the battery holder into the remote. Be sure to observe the correct polarity.
3. Align the battery holder with the remote control and push until the holder clicks.

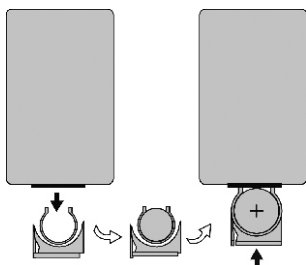

Remote Control Function Description

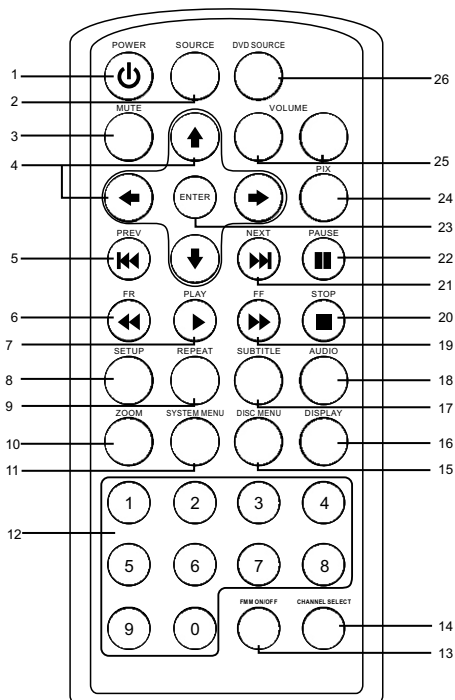

* Function control is available on the unit and the remote control.

1. POWER (⏻) Button*

Press this button to turn the unit ON and OFF.

2. SOURCE Button*

Each time the button is pressed, the audio / video source will change in the following sequence:

DVD > AV > AUX

NOTE: The USB device and the SD card can be accessed using the DVD source button. Refer to Item 26.

MUTE Button

Press this button to mute all the audio. Pressing the button again restores the sound to the previously set level.

4. CURSOR (▲▼◀▶) Buttons

Use these buttons to navigate the menu selection on the screen.

5. PREVIOUS (⏮) Button*

Press to return to the previous chapter or track.

6. FR SCAN BACKWARD (⏪) Button

Press to search in the backward direction. Press repeatedly to change the search speed from 2, 4, 8, 16 and 32 times the normal speed. Pressing the fifth time returns to normal speed..

7. PLAY (▶) Button*

Press to activate the play mode when a disc is loaded in the disc compartment, a USB memory device or a SD card is connected to the unit .

8. SETUP Button

Press the DVD button and SETUP button to display the Setup Menu which allows the user to change the DVD player options such as OSD Language, Video, Rating, etc. Refer to the settings and adjustment section for more information.

9. REPEAT Button

Allows the user to repeat a selected track, folder, title, chapter, or all.

10. ZOOM Button

Press this button to enlarge or decrease the picture size when playing a DVD disc.

Press ZOOM button

Once
Twice
3 Times
4 Times
5 Times
6 Times
7 Times

DVD Player performs

Enlarges the picture 2X
Enlarges the picture 3X
Enlarges the picture 4X
Reduces the picture 1/2
Reduces the picture 1/3
Reduces the picture 1/4
Picture is returned to original size

11. SYSTEM MENU Button

Press this button to enter the system menu which contains features and options to customize the screen display and change the OSD language.

12. NUMBER Buttons

Allows the user to enter numbers 0 to 9 for selection of CD tracks, DVD chapters, and passwords.

13. FMM ON/OFF Button

Turns the wireless FM Modulator on or off.

14. FMM CHANNEL SELECT Button

Selects the wireless FM Modulator Frequency:

(CH1 87.7MHz, CH2 88.1MHz, CH3 88.5MHz, CH4 88.9MHz, CH5 106.7MHz, CH6 107.1MHz, CH7 107.5MHz, CH8 107.9MHz.

15. DISC MENU Button

Press this button to enter the DVD root menu.

16. DISPLAY

Press to display current disc information while the disc is playing. The information displayed will be Title Elapsed, Title Remaining, Chapter Elapsed and Chapter Remaining. Pressing the button will also turn the display off.

17. SUBTITLE Button

Press to display and select the available subtitle language in DVD mode. Each time the button is pressed the subtitle language changes. Pressing the button will also turn the subtitles off.

NOTE: The type and number of subtitle languages vary from disc to disc.

18. AUDIO Button

Press to display and select the available AUDIO languages in DVD mode. Each time you press the button, the language changes.

NOTE: The audio languages vary from disc to disc.

19. FF SCAN FORWARD (▶▶) Button*

Press to search in the forward direction. Press repeatedly to change the search speed from 2, 4, 8, 16 and 32 times the normal speed.

20. STOP (■) Button*

Press to stop playback.

21. NEXT (▶) Button*

Press to skip to the next chapter or track.

22. PAUSE (||) Button*

Allows the user to pause the playback. Pressing pause again or pressing the Play button will resume normal playback.

23. ENTER Button

Used to implement a selected setting or menu option.

24. PIX (Picture Select) Button

Each time this button is pressed, the OSD picture adjustment displays the "Adjustment bar" for BRIGHTNESS, CONTRAST, COLOR, TINT (For NTSC only). Once the desired adjustment bar is displayed, use the VOLUME+ and VOLUME- button to adjust the setting. The display will automatically turn off if no adjustments are made within 6 seconds is pressed.

25. VOLUME DOWN (-) or UP (+)*

Press to select the level of the picture adjustments when the unit is in picture adjustment mode or to increase or decrease the volume for the wired headphones.

26. DVD Source*

This button is only active when remote control is in the DVD mode. Each time the button is pressed one of the sources (DVD, USB and SD Card) will be selected. If a USB device or SD Card is not plugged in, the unit will remain on DVD Source. Press to change source in sequence of DVD > USB > SD Card.

NOTE: The DVD Source button is used to access MP3 and audio CDs when these discs are in the disc compartment.

MENU ADJUSTMENT

The System Menu contains features and options that allow you to customize your system.

- 1) Press the “**□**” button on unit or press the TV button and the SYSTEM MENU button on the remote control, the menu display below will appear on screen.
- 2) Use the “+” “-” buttons to change the setting.
- 3) To select the next menu press the “**□**” button or the SYSTEM MENU button on the remote control.

MENU DISPLAY

The first adjustment to appear is the volume adjustment. The volume can be adjusted from 1 to 32.



The picture can be adjusted under the system menu. The picture adjustments consist of brightness (BRIGHT), CONTRAST, COLOR, TINT (for NTSC only). The adjustments range from 1 to 32.



The screen mode select feature allows the user to change the screen format (aspect ratio from 4:3 or to 16:9).



The IRT can be set to Channel A or Channel B for use with optional wireless headphones. The IRT function can also be set to off.



The FM Modulator adjustments consist of turning the FM Modulator on or off and selecting the FM Modulator frequency. The wireless FM Modulator Frequencies that can be selected are:

(CH1 87.7MHz, CH2 88.1MHz, CH3 88.5MHz, CH4 88.9MHz, CH5 106.7MHz, CH6 107.1MHz, CH7 107.5MHz, CH8 107.9MHz).



The OSD Language feature allows the user to select the language for the on-screen display. The user can either select English, Dutch, French, Spanish, Russian or Chinese for the OSD language.



The RESET function allows all setting options to be reset to factory settings.



SETTINGS AND ADJUSTMENTS

The Setup Menu contains features and options that let you customize your DVD player. For example, you can set a language for the on-screen display or prevent DVD playback for children.

Using the Setup Menu

1. Press the DVD and SETUP buttons on the remote. The Setup Menu appears on the screen. There are four menu pages which comprise the Setup Menu.
2. To select and set an option, use the cursor buttons (◀ or ▶) to move the highlight to the desired page.
3. After entering the highlighted page, use the cursor buttons (▲ or ▼) to highlight the desired option.
4. Press ▶ to open the sub menu that contains the different options available. Press ▲ or ▼ to highlight the desired option, and press ENTER to confirm the selection.
5. Repeat steps 3 and 4 to set the options that reside on the same menu page.
6. To change to another menu page, use the cursor buttons (◀ or ▶) then, repeat steps 2 through 5.

GENERAL PAGE

| General | Audio | Preference | Exit |
|---------------------------|-------|------------|------|
| General Setup Page | | | |
| TV Display | Wide | | |
| Screen Saver | On | | |
| Last Memory | On | | |
| Goto General Setup Page | | | |

TV Display

The TV Display feature allows the user to change the screen format (aspect ratio to 4:3 PScan, 4:3 LB, or 16:9 Wide).

1. To select the screen aspect ratio mode use the cursor button ▲ or ▼ to highlight TV DISPLAY. Press the cursor button ► to open the sub menu that contains the different options available. Press the cursor button ▲ or ▼ to highlight the desired option, and press ENTER to confirm the selection. Use the cursor button ◀ to return to the options.

Screen Saver

The closed captions feature allows the user to turn the screen saver function on or off.

1. To select the screen aspect ratio mode use the cursor button ▲ or ▼ to highlight CLOSED CAPTIONS. Press cursor button ► to open the sub menu that contains the different options available. Press the cursor button ▲ or ▼ to highlight the desired option, and press ENTER to confirm the selection. Use the cursor button ◀ to return to the options.

Last Memory

The last memory function allows DVD playback to begin from the point when playback was last stopped. The last memory feature allows the user to turn the last memory feature function on or off.

1. To select the screen aspect ratio mode use the cursor button ▲ or ▼ to highlight LAST MEMORY. Press the cursor button ► to open the sub menu that contains the different options available. Press the cursor button ▲ or ▼ to highlight the desired option, and press ENTER to confirm the selection. Use the cursor button ◀ to return to the options.

AUDIO SETUP PAGE

| General | Audio | Preference | Exit |
|-------------------------|-------|------------|------|
| Audio Setup Page | | | |
| Equalizer | | | |
| Sound Mode | | None | |
| Bass Boost | | Off | |
| Super Bass | | Off | |
| Treble Boost | | Off | |
| Goto Audio Setup Page | | | |

Sound Mode

The sound mode feature allows the user to apply preset sound effects to the unit's audio output signal. The user may choose from: None, Rock, Pop, Live, Dance, Techno, Classic and Soft.

1. To select the sound mode use the cursor button ▲ or ▼ to highlight SOUND MODE. Press the cursor button ► to open the sub menu that contains the different options available. Press the cursor button ▲ or ▼ to highlight the desired option, and press ENTER to confirm the selection. Use the cursor button ◀ to return to the options.

Bass Boost

The bass boost feature increases the audio bass response and allows the function to be turned on or off.

1. To select the bass boost feature use the cursor button ▲ or ▼ to highlight BASS BOOST. Press the cursor button ► to open the sub menu that contains the different options available. Press the cursor button ▲ or ▼ to highlight the desired option, and press ENTER to confirm the selection. Use the cursor button ◀ to return to the options.

Super Bass

The super bass feature increases the audio bass response and allows the function to be turned on or off.

1. To select the super bass boost feature use the cursor button ▲ or ▼ to highlight SUPER BASS. Press the cursor button ► to open the sub menu that contains the different options available. Press the cursor button ▲ or ▼ to highlight the desired option, and press ENTER to confirm the selection. Use the cursor button ◀ to return to the options.

Treble Boost

The treble boost feature increases the audio treble response and allows the function to be turned on or off.

1. To select the treble boost feature use the cursor button ▲ or ▼ to highlight TREBLE BOOST. Press the cursor button ► to open the sub menu that contains the different options available. Press the cursor button ▲ or ▼ to highlight the desired option, and press ENTER to confirm the selection. Use the cursor button ◀ to return to the options.

PREFERENCE PAGE

| General | Audio | Preference | Exit |
|------------------------|-------|------------|------|
| Preference Page | | | |
| TV Type | | NTSC | |
| Audio | | Eng | |
| Subtitle | | Eng | |
| Disc Menu | | Eng | |
| Parental | | | |
| Password | | | |
| Default | | | |
| Goto Preference Page | | | |

NOTE: This menu page available if there is no disc in the disc tray, the disc tray is open or the disc in the disc tray is stopped.

There are seven items in the PREFERENCE PAGE. They are TV TYPE, AUDIO, SUBTITLE, DISC MENU, PARENTAL, PASSWORD, and DEFAULT. The Preference page can only be accessed when the disc compartment is empty.

TV Type

This function matches video output of the unit to the broadcast system of a connected TV. The unit supports both National Television System Committee (NTSC) and Phase Alternating Line (PAL) television broadcasting standards.

Options:

PAL: Select this mode if the connected TV is a PAL system. The video signal of a NTSC disc will be output in PAL format.

AUTO: Select this mode if the connected TV is multi-system. The output format of video signal will be in accordance with the video signal of the disc.

NTSC: Select this mode if the connected TV is a NTSC system. The video signal of a PAL disc will be output in NTSC format.

1. To select the TV type use the cursor button ▲ or ▼ to highlight TV TYPE. Press the cursor button ► to open the sub menu that contains the different options available. Press the cursor button ▲ or ▼ to highlight the desired option, and press ENTER to confirm the selection. Use the cursor button ◀ to return to the options.

Audio Menu

This item allows a user to select a preferred audio language. This function only applies to discs encoded with different audio languages.

Options: English, French, Spanish, Chinese, Japanese, Korean, Russian, and Thai.

NOTE: If the selected language is not available for the currently playing disc, the disc's default setting is applied.

1. To select the audio feature use the cursor button ▲ or ▼ to highlight AUDIO. Press the cursor button ► to open the sub menu that contains the different options available. Press the cursor button ▲ or ▼ to highlight the desired option, and press ENTER to confirm the selection. Use the cursor button ◀ to return to the options.

Subtitle

This item allows a user to select a preferred subtitle language. This function only applies to discs encoded with subtitles.

Options: English, French, Spanish, Chinese, Japanese, Korean, Russian, and Thai.

NOTE: If the selected language is not available for the currently playing disc, the disc's default setting is applied.

1. To select the subtitle feature use the cursor button ▲ or ▼ to highlight SUBTITLE. Press the cursor button ► to open the sub menu that contains the different options available. Press the cursor button ▲ or ▼ to highlight the desired option, and press ENTER to confirm the selection. Use the cursor button ◀ to return to the options.

Disc Menu

This item allows a user to select a preferred disc menu language.

Options: English, French, Spanish, Chinese, Japanese, Korean, Russian, and Thai.

NOTE: If the selected language is not available for the currently playing disc, the disc's default setting is applied.

1. To select the disc menu feature use the cursor button ▲ or ▼ to highlight DISC MENU. Press the cursor button ► to open the sub menu that contains the different options available. Press the cursor button ▲ or ▼ to highlight the desired option, and press ENTER to confirm the selection. Use the cursor button ◀ to return to the options.

Parental

This item allows the user to limit the content of movie playback from Kid Safe to Adult. The lower the value, the more strict the control. Movies rated higher than the level set for the parental lock can not be viewed without entering the correct password.

Options:

- 1 G
- 2 PG
- 3 PG – 13
- 4 R
- 5 NC17
- 6 Adult

NOTE: The rating level can be changed only when the correct password is provided. This function only works with those discs with parental function.

1. To select the parental feature use the cursor button ▲ or ▼ to highlight PARENTAL. Press the cursor button ► to open the sub menu that contains the different options available. Press the cursor button ▲ or ▼ to highlight the desired option, and press ENTER to confirm the selection. Use the cursor button ◀ to return to the options

Password

This item allows a user to change the password. The default password is 3308.

1. To select the password feature use the cursor button ▲ or ▼ to highlight PASSWORD. Press the cursor button ► to open the sub menu that contains the different options available. Press the cursor button ▲ or ▼ to highlight the desired option, and press ENTER to confirm the selection.

To change the password:

1. Enter the old password in the OLD PASSWORD row.
2. Enter the new password in the NEW PASSWORD row.
3. Enter the new password again in the CONFIRM PWD row.

NOTE: You may reset the password if you forget the old password by using the default password: 3308. This password is always active even after you have selected your own password and changed it. To avoid the possibility of others using the default password to set the parental level and change the password, record this default password in another area and delete it from this manual.

2. Use the cursor button ◀ to return to the options.

Default

This item allows a user to restore all the default settings except the settings in the Password Setup Page and the PARENTAL item.

1. To select the default feature use the cursor button ▲ or ▼ to highlight DEFAULT. Press the cursor button ► to open the sub menu that contains the different options available. Press the cursor button ▲ or ▼ to highlight the desired option, and press ENTER to confirm the selection. Use the cursor button ◀ to return to the options.

EXIT SETUP PAGE

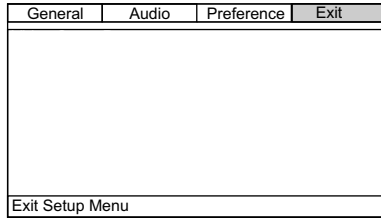

Exit Setup Page

The exit setup page allows the user to exit the setup menu and return to the DVD playback.

1. To exit the setup page use the ► to highlight EXIT and press ENTER to confirm the selection.

Playing DVDs

Press the DISPLAY button on the remote control to display the status banner. The banner includes disc title, chapter, and elapsed time.

Title selection

Press numeric (0-9) buttons to initiate a change of chapter title selection. Then press ENTER to implement the selection.

Playing USB

The System will detect the insertion of the USB media automatically if no disc is loaded. The system only auto detects the first media inserted (DVD or USB drive); the second media source, SD card or CD disc must be manually selected by pressing the DVD source button on the remote control.

When a disc is inserted, the system will switch to DVD mode immediately regardless if USB media is currently playing. The DVD source (DVD or USB) can only be changed while the DVD is not playing. When a USB device is loaded in the player, the navigation menu appears automatically.

1. Press the cursor button ▲ or ▼ to move the highlight to the desired folder and press ENTER to display the contents in the folder.
2. Press the cursor button ▲ or ▼ to move the highlight to the desired file in the folder and press ENTER to begin playback of the highlighted file.

Note: The System supports:

Files: MP3 and JPEG files only.

File systems: FAT16 and FAT32

The system will NOT support:

Files: BMP, M4P, WAV, ASF, H.264, DivX, WMA

File systems: NTFS, ExFAT

The system will always default to the DVD when the system detects a disc in the DVD player.

Playing Audio CDs

When playing an audio CD, the DISPLAY banner appears automatically. The track number and the elapsed time of the disc are displayed.

Selecting a Track

Selection of a specific track is accomplished by using the numbers keys. Press the number key corresponding to the desired track and press ENTER and the player will implement the selection.

Using the REPEAT feature

The default mode for the Repeat feature is OFF. Pressing REPEAT consecutively changes the repeat options

- TRACK – repeat the track that is playing.
- ALL – repeat the entire disc that is playing.
- REPEAT OFF – repeat is turned off.

Playing MP3 Discs

MP3 is a format for storing digital audio. An audio CD-quality song can be compressed into MP3 format with very little loss of quality, while taking up much less space. CD-R discs that have been encoded in MP3 format can be played on the DVD player. The DVD player plays the songs in the order they were burned on to the disc.

Selecting Folders and Songs

When an MP3 disc is loaded in the player, the navigation menu will appear on the screen automatically.

Press the cursor button, ▲ or ▼, to move the highlight to the desired folder and press the ENTER button to display the songs in the folder.

Press the cursor button, ▲ or ▼, to move the highlight to the desired song and press the ENTER button to begin playback of the highlighted song.

Selecting a Play Mode

You can choose what order the songs will play on a disc temporarily. The default play mode is FOLDER. Press REPEAT consecutively to choose the desired play mode. The play mode options are :

- Repeat One Repeat the song that is playing.
- Repeat Folder Repeat the disc that is playing.
- Repeat Off Turn off repeat function.

Playing SD Card

The System will detect the insertion of the SD Card automatically if no disc is loaded. The system only auto detects the first media inserted (DVD or the second media source, USB device ,SD card or CD disc must be manually selected by pressing the DVD source button on the remote control.

When a disc is inserted, the system will switch to DVD mode immediately regardless if SD Card media is currently playing. The DVD source can only be changed while the DVD is not playing. When a SD Card is loaded in the player, the navigation menu appears automatically.

1. Press the cursor button ▲ or ▼ to move the highlight to the desired folder and press ENTER to display the contents in the folder.
2. Press the cursor button ▲ or ▼ to move the highlight to the desired file in the folder and press ENTER to begin playback of the highlighted file.

The system will always default to the DVD when the system detects a disc in the DVD player.

DVD Basics

To get the optimum use out of the DVD Player, please read the following:.

DVD Region Code

The DVD player is preset to a region code at the factory depending on where the DVD player is sold. A DVD from a different region cannot be played in this unit and the unit will display "WRONG REGION".

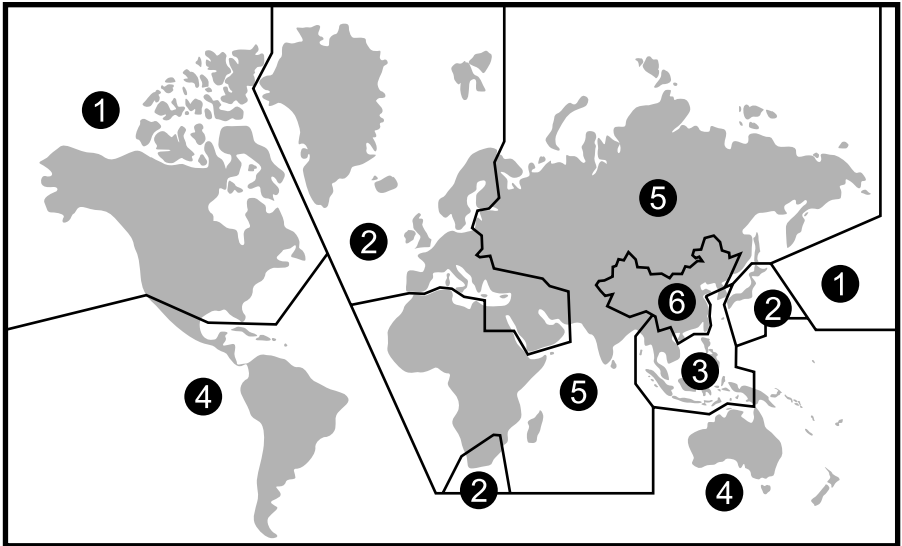

Region 1- USA, Canada

Region 2- Japan, Europe, South Africa, Middle East, Greenland

Region 3- S. Korea, Taiwan, Hong Kong, Parts of South East Asia

Region 4- Australia, New Zealand, Latin America (including Mexico)

Region 5- Eastern Europe, Russia, India, Africa

Region 6- China

TROUBLESHOOTING

| PROBLEM | SOLUTION |
|---|--|
| IR remote inoperative | <ul style="list-style-type: none">• Verify that the battery in the remote is fresh.• Verify that the remote sensor eye is not obstructed. |
| Disc won't play | <ul style="list-style-type: none">• Insert a disc with the label side facing upwards.• Check the type of disc you put into disc tray. This DVD only plays DVD, audio CD and MP3s.• Both the unit and the disc are coded by region. If the |
| Play starts, but then stops immediately | <ul style="list-style-type: none">• The disc is dirty. Clean it.• Condensation has formed. Allow player to dry out. |
| No sound or distorted sound | <ul style="list-style-type: none">• Make sure your DVD is connected properly. Make sure all cables are securely inserted into the appropriate jacks.• If you are using the 2-channel IR headphones, make sure you turn on the IR headphone power, make sure the correct channel (A or B) is selected.• If the FM Modulator is ON make sure proper frequency has been selected. |
| Cannot advance through a movie | <ul style="list-style-type: none">• Most discs prohibit advancing through the opening credits and warning information that appear at the beginning of movies. |
| The icon (⓪) appears on screen | <ul style="list-style-type: none">• The feature or action cannot be completed at this time because:<ol style="list-style-type: none">1. The disc's software restricts it.2. The disc's software doesn't support the feature (e.g., angles)3. The feature is not available at the moment.4. A title or chapter number that is out of range has been requested. |
| Picture is distorted | <ul style="list-style-type: none">• The disc might be damaged. Try another disc.• It is normal for some distortion to appear during |



12 MONTH LIMITED WARRANTY

Applies to Movies To Go Mobile Video Products

AUDIOVOX ELECTRONICS CORP. (the Company) warrants to the original retail purchaser of this product that should this product or any part thereof, under normal use and conditions, be proven defective in material or workmanship within 12 months from the date of original purchase, such defect(s) will be repaired or replaced with reconditioned product (at the Company's option) without charge for parts and repair labor. A game controller, if supplied, is similarly warranted for ninety (90) days.

To obtain repair or replacement within the terms of this Warranty, the product is to be delivered with proof of warranty coverage (e.g. dated bill of sale), specification of defect(s), transportation prepaid, to the Company at the address shown below.

This Warranty does not extend to the elimination of externally generated static or noise, to correction of antenna problems, to costs incurred for installation, removal or reinstallation of the product, or to damage to digital memory/media devices, gaming devices, discs, speakers, accessories, or vehicle electrical systems.

This Warranty does not apply to any product or part thereof which, in the opinion of the Company, has suffered or been damaged through alteration, improper installation, mishandling, misuse, neglect, accident, or by removal or defacement of the factory serial number/bar code label(s). THE EXTENT OF THE COMPANY'S LIABILITY UNDER THIS WARRANTY IS LIMITED TO THE REPAIR OR REPLACEMENT PROVIDED ABOVE AND, IN NO EVENT, SHALL THE COMPANY'S LIABILITY EXCEED THE PURCHASE PRICE PAID BY PURCHASER FOR THE PRODUCT.

This Warranty is in lieu of all other express warranties or liabilities. ANY IMPLIED WARRANTIES, INCLUDING ANY IMPLIED WARRANTY OF MERCHANTABILITY, SHALL BE LIMITED TO THE DURATION OF THIS WRITTEN WARRANTY. ANY ACTION FOR BREACH OF ANY WARRANTY HEREUNDER INCLUDING ANY IMPLIED WARRANTY OF MERCHANTABILITY MUST BE BROUGHT WITHIN A PERIOD OF 24 MONTHS FROM DATE OF ORIGINAL PURCHASE. IN NO CASE SHALL THE COMPANY BE LIABLE FOR ANY CONSEQUENTIAL OR INCIDENTAL DAMAGES FOR BREACH OF THIS OR ANY OTHER WARRANTY. No person or representative is authorized to assume for the Company any liability other than expressed herein in connection with the sale of this product.

Audiovox Electronics Corporation,
150 Marcus Blvd., Hauppauge, New York 11788 | 1-800-645-4994

128-6429F

NOTES



For Customer Service
Visit Our Website At
www.mobile.audiovox.com
Product Information, Photos,
FAQ's Owner's Manuals